**INSTALLATION, OPERATION and
MAINTENANCE MANUAL**

**MODEL DCPF1 70 thru 225 A
SCR POWER CONTROLS**

CE – See last page of manual for CE Declaration of Conformity



AMETEK HDR POWER SYSTEMS
3563 INTERCHANGE ROAD
COLUMBUS, OH 43204

TEL: 614-308-5500
TOLL FREE: 1-888-797-2685
FAX: 614-308-5506



SCR Power Controls and Systems

Dear Client:

On behalf of all of AMETEK HDR's employees, I want to take this opportunity to "thank you" for purchasing an AMETEK HDR Power Systems' SCR Power Control.

We believe AMETEK HDR represents the best overall solution to your SCR Power Control needs in the industry today. We do this by providing a quality manufactured, reliable unit with fast, on-time delivery and a competitive price.

All of our employees are dedicated to your success. If you have any questions, comments or concerns, please call me toll free at 1-888-PWR-CNTL (797-2685).

Sincerely,

AMETEK HDR POWER SYSTEMS

A handwritten signature in cursive script that reads "George A. Sites".

George A. Sites
Vice President

GAS/be

REVISION PAGE

<u>Page</u>	<u>Change</u>	<u>Revision</u>	<u>Date</u>
-------------	---------------	-----------------	-------------

NOTE: SPECIFICATIONS SUBJECT TO CHANGE WITHOUT PRIOR NOTICE.

COPYRIGHT 2009

AMETEK HDR POWER SYSTEMS.

TABLE OF CONTENTS

<u>Para.</u>	<u>Title</u>	<u>Page</u>
Section 1 - DESCRIPTION		
1-1	Models Covered	1
1-2	General Description	1
1-3	Applications	1
1-4	Specifications.....	1
1-5	Options.....	1
1-6	Operation.....	3
1-7	Diagnostic Indicators	3
Section 2 - INSTALLATION		
2-1	Mounting.....	4
2-2	Line/Load Power Wiring.....	4
2-3	Thermostat Wiring.....	5
2-4	Input Line Voltage Changes.....	5
2-5	Safety Issues.....	5
Section 3 - COMMAND SIGNAL CALIBRATION AND WIRING		
3-1	Zero and Span Adjustments	8
3-2	Command Indicator.....	8
3-3	Isolated and Non-Isolated Inputs.....	8
3-4	Remote Manual Control.....	9
3-5	Process Command Signal	9
3-6	Auto/Manual Control.....	10
3-7	ON/OFF Control	10
3-8	Shutdown (Disable)	11
Section 4 - OPTIONS CALIBRATION		
4-1	Current Limit (CL).....	13
4-2	Current Regulation (CR).....	13
4-3	Current Transformer Connections	14
Section 5 - MAINTENANCE		
5-1	Environmental Concerns.....	15
5-2	Line/Load Power Connections.....	15
5-3	Static Precautions When Servicing.....	15
5-4	Troubleshooting Typical Symptoms.....	15

Section 6 - SERVICE AND PARTS

6-1 Customer Service17
6-2 Spare Parts17
6-3 Warranty.....17

TABLES AND ILLUSTRATIONS

TABLES

<u>Table</u>	<u>Title</u>	<u>Page</u>
1	Specifications for the DCPF1	2
2	Lug Size/Torque Information.....	4
3	Troubleshooting the DCPF1	16

ILLUSTRATIONS

<u>Figure</u>	<u>Title</u>	<u>Page</u>
1	Line/Load Power Wiring.....	6
2	Outline and Mounting	7
3	Remote Manual Control.....	9
4	Auto/Manual Control	10
5	ON/OFF Control	11
6	Firing Circuit Terminals and DIP Switches	12

NOTE: If full size drawings are required, contact AMETEK HDR inside sales and request the required drawing by the drawing number listed above.

Section 1 - DESCRIPTION

1-1 MODELS COVERED

This manual covers the DCPF1 models rated 70 thru 225 amperes and its options.

1-2 GENERAL DESCRIPTION

The DCPF1 is a solid-state, single-phase, phase-fired (PF) SCR power control which will operate on voltages up to 575 VAC and has a DC voltage output. It accepts most all standard process command signals and regulates the output DC voltage. Zero and Span Multi-turn potentiometers are provided to ease calibration. The DCPF1 utilizes phase-lock loop technology to insure precise timing and noise immunity. The power SCR assembly consists of two SCRs and two Diodes connected in a full-wave bridge configuration with a semiconductor fuse, RC Snubber and MOV protection. Terminals are provided to ease installation. Diagnostic indicators are provided to aid troubleshooting.

1-3 APPLICATIONS

The DCPF1 provides infinitely variable firing angles for precise control of DC Voltage to resistive or inductive loads.

1-4 SPECIFICATIONS

Refer to Table 1 for specifications on the DCPF1 Power Control.

1-5 OPTIONS

Three options are available: Over-temperature Thermostat, RMS Current Limit and AC Overcurrent Trip.

Over-temperature thermostats are available and can be specified as either Normally Open (NO) or Normally Closed (NC).

RMS Current Limit (Option CL) is available and includes an Overcurrent Trip with a Form C relay output. The adjustment range is approximately 30 to 125% of the unit's AC line current rating for the Current Limit and 30 to 200% for the Overcurrent Trip.

An Overcurrent Trip (Option OC) with a Form C relay output is available for those applications where Current Limit is not required. This would normally be used on loads that have instantaneous shorts that are self-healing. The adjustment range is 30 to 200%.

Table 1
Specifications for the DCPF1 70 thru 225 Models

CONTROL METHOD	- Phase firing of back to back SCR's DC output
VOLTAGE RATINGS	- 120, 240, 400, 480, 575VAC, 1 Ph., 50/60 Hz.
CURRENT RATINGS	- 70A, 90A, 120A, 180A, 225A
COMMAND SIGNAL	- 4-20ma, 0-5VDC/0-10VDC, manual control.
ISOLATION	- 2500Vrms from line/load to command signal, 500Vrms to ground.
LINEARITY	- Output DC voltage is linear to command signal.
VOLTAGE REG.	- $\pm 1\%$ for $\pm 10\%$ line voltage change.
SCR PROTECTION	- Current surge, semi-conductor fuses; transient voltage, metal oxide varistor (MOV) and RC snubber.
ADJUSTMENTS	- Zero and Span, multi-turn.
DIAG. INDICATORS	- Control power, command signal.
AMBIENT TEMP.	- Operating 0 - 50 °C, Storage -10 - 70 °C
WEIGHT	- 33 lbs.

1-6 OPERATION

The DCPF1 controls power by the switching action of two SCRs connected with two diodes, in a bridge rectifier configuration. The gating of these SCRs is synchronized with the line frequency (either 50 or 60 HZ) by the phase locked loops built into the firing circuit. A soft-start feature is standard, which allows the DCPF1 to fire into inductors. The output may be adjusted by the on-board multi-turn potentiometers or by a voltage or current signal from a process controller. Zero and Span controls allow the user to calibrate the SCR unit's output to the process command signal. Terminals are available for connection of a remote manual potentiometer.

1-7 DIAGNOSTIC INDICATORS

Two diagnostic indicators (LEDs) are provided: Control Power (Red), lights when control power is applied and Command Signal (Green), varies in brilliance with command signal. Blown Fuse (Yellow) lights when semiconductor fuse clears.

Section 2 - INSTALLATION

2-1 MOUNTING

Prior to mounting, verify the voltage and current rating. The information is provided on the unit's nameplate. Determine the mounting dimensions from the outline drawing from Figure 2. Mount the DCPF1 so that air flow is upward through the power controller. Ensure that air flow is unrestricted. Allow plenty of room.

2-2 LINE/LOAD POWER WIRING

Connect the line/load using appropriately sized and insulated wire/cable per NEC based on the voltage and current rating of the DCPF1. Refer to Figure 1. Cable lugs are provided. Refer to Table 2 for lug sizes and torque information.

WARNING

Hazardous voltages exist at the power controller heat sinks and at the load at all times when the input voltage is connected. This condition exists even when the controller is set to deliver zero output.

Table 2

Lug Size/Torque Information - 70 thru 225 Models

<u>Model</u>	<u>Size Wire/Cable</u>	<u>Torque</u>
70 thru 225	8 to 0 AWG	35 to 45 in. Lbs.

WARNING

Branch circuit overcurrent protection is required to be provided in accordance with the national and/or local code of the inspecting authority or equivalent.

2-3 THERMOSTAT WIRING

Normally Open or Normally Closed may be specified on the 70 thru 225 models as an option. Thermostat connections are on terminals 23 & 24.

2-4 INPUT LINE VOLTAGE CHANGES

All units are shipped wired for the line voltage specified on the order. If some other voltage is required, it is a simple matter to change it. Open the door on the Power Control and locate transformer T1. Unsolder and move the white/black wire to the appropriate voltage tap. Switch SW3 must be placed in the proper position for the line frequency. On older units SW3 was preceded by Jumpers J1 and J2, which must be removed for 50 Hz. operation.

CAUTION
Hazardous voltages exist at the Power Controller's heatsink and at the load at all times when the input voltage is connected. This condition exists even when the Power Controller is set to deliver zero output.

2-5 Safety Issues

The rated operational voltage of each Power Controller is shown on it's nameplate, i.e. 120V, 240V, 400V, 480V and 575V. The Power Controller is designed to operate between +10% and -15% of this rated operational voltage in an Over Voltage Category III environment.

The voltage drop across the switching semiconductor while in the conducting mode is approximately 1.5 volts and is somewhat a function of current. To calculate the Power Control's power loss, multiply the load current.

The minimum operational current is approximately 1 amp and the maximum off state current is approximately 15 ma.

WARNING
Power Control units are not suitable to provide isolation due to the use of semiconductors and other components that allow a small current to flow from line to load even when the unit is in the non-conducting mode.

The Power Controllers described in this instruction manual are designed to operate in a pollution degree 2 environment.



HAZARDS EXIST



DANGEROUS VOLTAGES EXIST

**Figure 1
LINE/LOAD POWER WIRING**

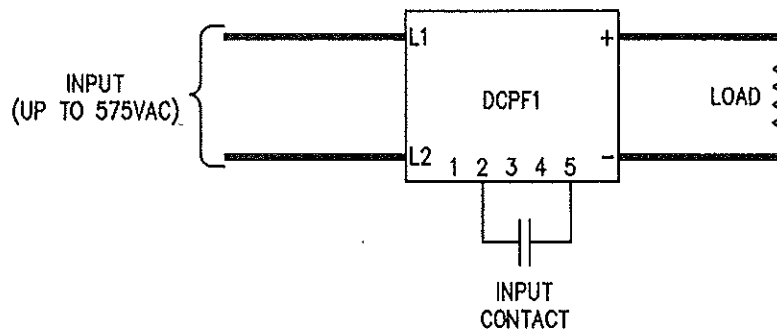
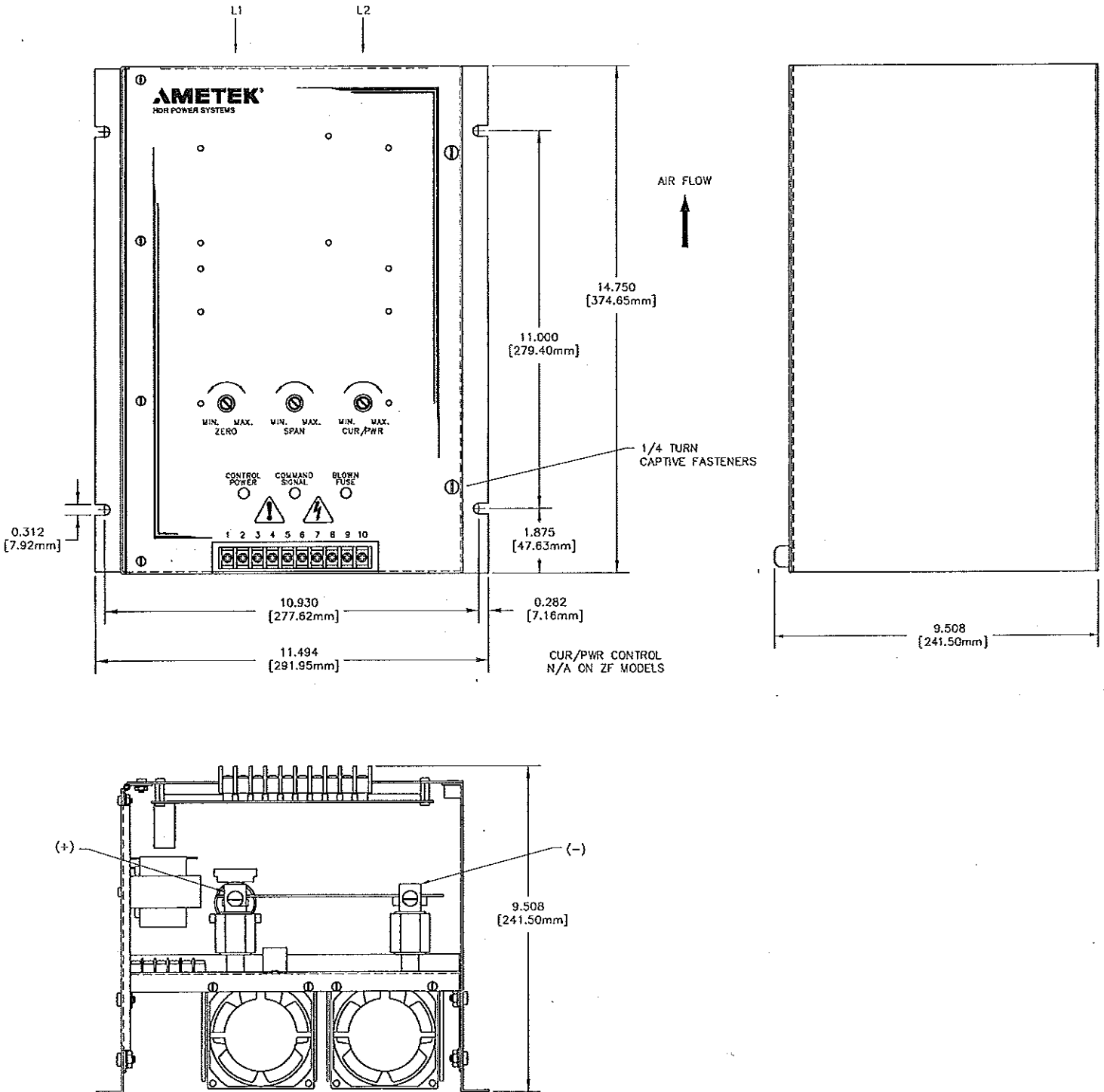

Figure 2
OUTLINE AND MOUNTING



Section 3 - COMMAND SIGNAL CALIBRATION AND WIRING

3-1 ZERO AND SPAN ADJUSTMENTS

All DCPF1s have both Zero and Span potentiometers used for matching the SCR Power Control and the Command Signal. The Zero control is for the low end input (min. output) adjustments while the Span Control is used for the high end input (max. output).

The Zero control has both the negative and positive voltage available making it usable as a manual or zero control. By turning the control clockwise, the output will increase proportionally to the adjustment. Turning it counter-clockwise will decrease or zero the output.

The Span control is used to adjust the maximum desired output. It will adjust for either a remote manual control or a command signal input. Clockwise adjustment increases the output while counter-clockwise adjustment decreases the output.

3-2 COMMAND INDICATOR

The Command Indicator is a green Light Emitting Diode (LED) located on the front cover of the unit. The brilliance of this LED will change with the Command Signal. The brilliance increases with an increased Command Signal and decreases with a decreased Command Signal.

3-3 ISOLATED AND NON-ISOLATED INPUTS

The DCPF1 has the capability of having either an isolated or non-isolated Command Signal input. It will always be shipped with an isolated input unless specified otherwise (known exception is a Manual Control input.) The standard input impedance is 500 ohms for isolated and 1500 ohms for non-isolated.

On units with DIP switches select "isolated" position for 4-20ma inputs and "non-isolated" for voltage inputs. On older units an isolated input can be changed to a non-isolated input by simply unsoldering jumpers J3 and J4 on the firing circuit and moving them to the non-isolated position on the firing circuit.

The isolated input works best with an offset Command Signal such as 4-20ma; however, it will work with both offset and zero based Command Signals. Zero based Command Signals may have a small amount of non-linearity (input to output) at the low end. This should not be a problem on closed loop systems.

3-4 REMOTE MANUAL CONTROL

Some applications only require a manual control input and not a closed loop input from a process controller. The DCPF1 is designed to accept a remote manual control input (refer to Figure 3 for connections.)

Adjustments are simple and quick, but first verify that the firing circuit is set up for non-isolated input and that R29 has been removed. Next start with the Remote Manual Control in the zero (counter-clockwise) position, apply power to the Power Control. Adjust the Zero Control so the Power Control's output just starts to come on, then adjust it counter-clockwise so the unit's output is at zero. Now adjust the Remote Manual Control to the full output (clockwise) position, and adjust the Span Control until the maximum desired output is reached. This procedure may have to be repeated due to some interaction between the Zero and Span controls.

Figure 3
REMOTE MANUAL CONTROL

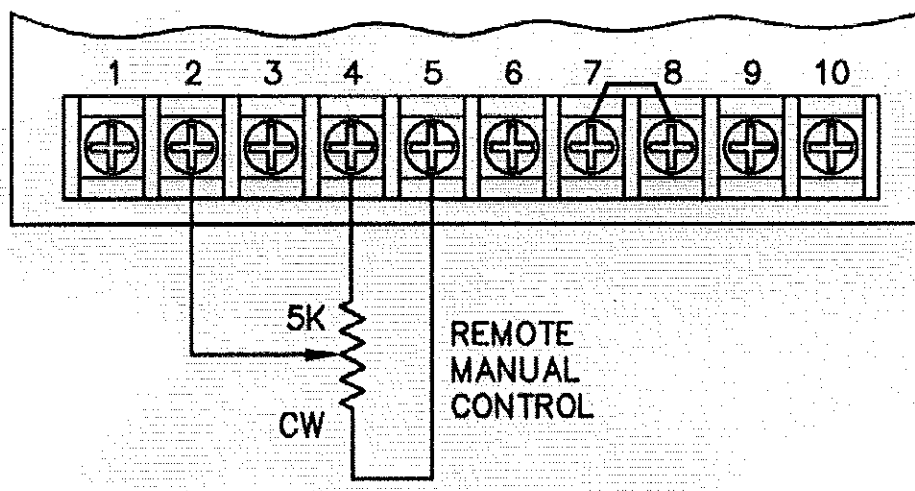

NOTE: Use DC voltmeter to monitor output voltage.
A load must be present when making adjustments.

3-5 PROCESS COMMAND SIGNAL

Process command signals can be either offset or zero based as discussed earlier. Simply connect the command signal to terminals 1 (-) and 2 (+) on the firing circuit and adjust the Zero and Span controls. Adjustments are easy. Simply have the process controller's output set at minimum and adjust the Zero control so the unit's output is at zero. Next have the process controller's output set at maximum and adjust the Span control for the maximum desired output. As with the Remote Manual Control, some interaction between controls does exist so repeating this procedure may be necessary - see Figure 8 for connections.

3-6 AUTO/MANUAL CONTROL

On closed loop processes it may be desirable to be able to operate the DCPF1 manually. The DCPF1 has this capability designed into it. Connect the Command Signal, a Remote Manual control and an Auto/Manual switch in the Auto position. By switching to the Manual position, the Remote Manual control operates and the auto signal is disconnected.

Figure 4
Auto/Manual Control

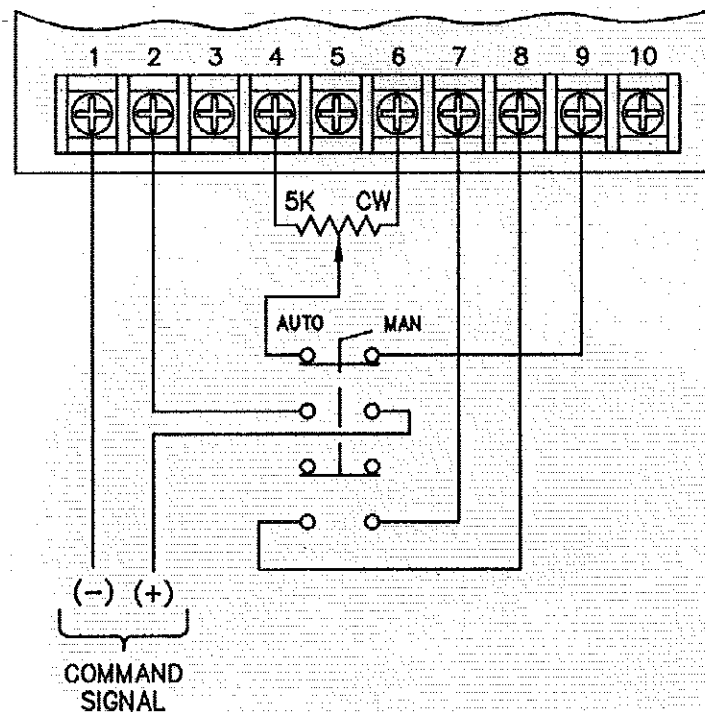

NOTE: Some non-linearity will occur with the Manual Control.

3-7 ON/OFF CONTROL

Some applications require that a simple ON/OFF type control be used. The DCPF1 can be used in these simple applications. It can be connected for turn on by a contact closure.

For on/off control, wire the contact according to figure 5. Once the wiring is complete, turn on the input power. Set the input contact to open and adjust the Zero control clockwise until the unit comes on, then adjust counter-clockwise until the unit just shuts off. Now set the input contact to the closed position and adjust the Span control clockwise until the unit's output is at the desired maximum output level. Repeating of this procedure may be necessary due to some interaction between the Zero and Span controls.

Figure 5
ON/OFF CONTROL

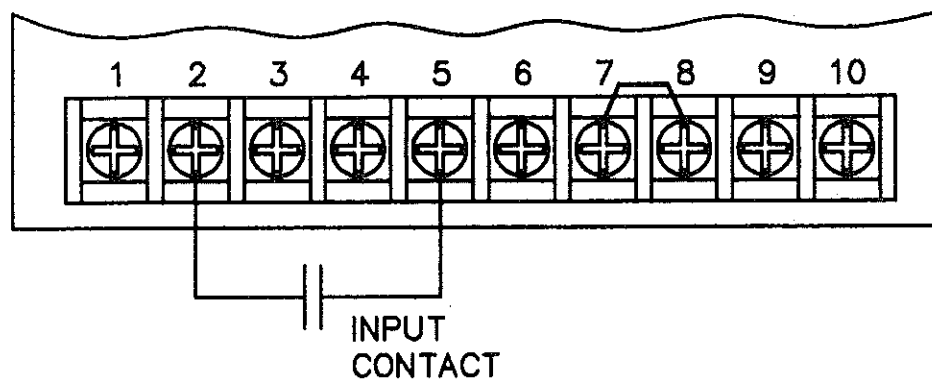

3-8 SHUTDOWN (DISABLE)

When it is necessary to shutdown or disable the output, it is a simple matter. Connect a dry contact closure between terminals 3 and 4 of the firing circuit. When it is closed, the power control will be shut off.

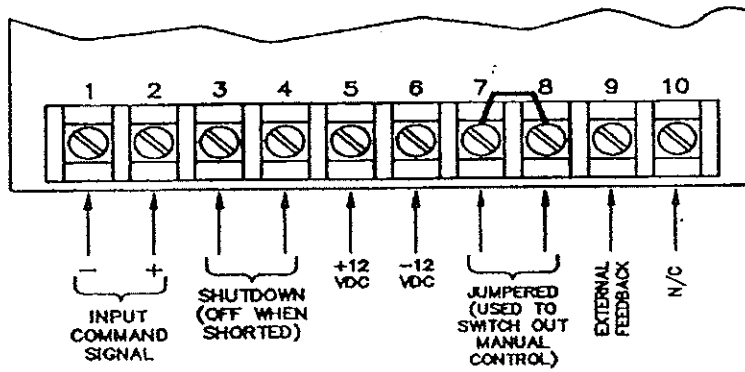
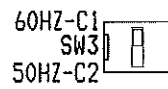
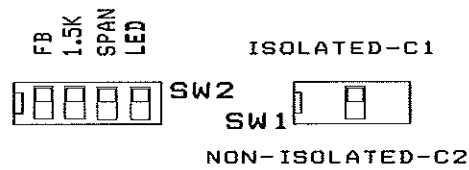

Figure 6
 FIRING CIRCUIT TERMINALS and DIP SWITCHES



Section 4 - OPTIONS CALIBRATION

NOTE: The Zero and Span Controls should be adjusted prior to adjusting any of the options. The options have been factory set, but if the option's adjustments are questionable, re-adjust the controls to full clockwise, and then proceed with the following adjustments. Most likely no adjustment of the option will be required. Always use a true RMS reading ammeter when making adjustments.

NOTE: All current transformers are shipped loose.

4-1 CURRENT LIMIT (CL)

The available Current Limit is a true RMS current limiting device which includes an overcurrent trip circuit. The adjustment range for the current limit is approximately 30 to 125% of the unit's rating and 30 to 200% for the overcurrent trip. Both adjustments are multi-turn potentiometers. The current limit adjustment is on the front of the DCPF1, while the overcurrent trip adjustment is inside on the current limit PCB.

If adjustment is required, adjust the command signal to full on. Next adjust the Current Limit control counter-clockwise from full clockwise position. Stop adjusting when the unit's RMS output current is at the desired maximum level. Next adjust the overcurrent trip control counter-clockwise until the unit trips off, then adjust it clockwise a small amount. This may require a few tries. Refer to paragraph 4-3 for overcurrent relay output, and remote reset PB connections.

NOTE: The current limit current transformer must be installed on the AC line.

Re-adjust the overcurrent trip control as described in paragraph 4-1. Refer to paragraph 4-3 for overcurrent relay output and remote reset PB connections.

4-2 OVERCURRENT TRIP (OC)

This option is for those applications which do not require current limit but is likely to suffer from instantaneous faults in the load.

The overcurrent trip adjustment is on the front of the unit. It's adjustment range is from 30 to 200% of the unit's current rating.

If adjustment is necessary, have the command signal set at maximum and adjust the overcurrent trip control as necessary until the unit shuts off. Re-adjust the control clockwise until the unit will operate properly.

Another feature of the overcurrent trip is an automatic reset. This is included with the current limit and current regulation. Open the unit and locate the auto reset switch and reset pushbutton. With this switch in the on position, the unit will continue to reset until the fault clears. If in the off position, the unit will remain shut off until the reset PB is operated. The auto reset switch will always be in the off position unless specified on the order.

The overcurrent trip includes a Form C relay output and provisions for a remote overcurrent reset PB. The relay output terminals are 35 and 36 for the N.C. and 36 and 37 for the N.O. The remote reset PB connects to terminals 33 and 34.

4-3

CURRENT TRANSFORMER CONNECTIONS

For the current limit, current regulation, overcurrent trip and the power regulation option, the remotely mounted current transformer (5A secondary) should be used connected to terminals 31 and 32. If erratic control is noticed (power regulation only) reverse the current transformer secondary connections.

Section 5 - MAINTENANCE

5-1 ENVIRONMENTAL CONCERNS

Always verify that the DCPF1 is mounted in a clean, dust free environment. Clean the heat sink and printed circuit board periodically so no dust and/or dirt accumulates on the unit. Dust and/or dirt can prevent proper airflow causing overheating of the semiconductors. Conductive dust and/or dirt can cause shorts or arcing, which can cause damage to the unit.

Always size your enclosure so that a 50 °C maximum internal ambient temperature is never exceeded.

5-2 LINE/LOAD POWER CONNECTIONS

Periodically turn the power off to the DCPF1 and check for corrosion and tightness of the power connections. If any corrosion is evident, clean the cable and connector and reconnect making sure to tighten according to our torque specifications in Table 2.

5-3 STATIC PRECAUTIONS WHEN SERVICING

When servicing the Firing Circuit or option Printed Circuit Board (PCB), damage can occur due to static electricity. Always use a wrist strap grounded through a 1 megohm resistor. Transport the PCB in a static shielding bag. Caution in handling the PCB can help prevent any further damage to the PCB.

If you are not familiar with static precautions, consult the factory for additional details.

5-4 TROUBLESHOOTING TYPICAL SYMPTOMS

Any one of the following symptoms usually indicate a problem with the DCPF1:

1. No output regardless of the input.
2. Full output regardless of the input.
3. Output is not variable from 0 to full.

Refer to Table 3 for help in troubleshooting. If you cannot diagnose the problem, call HDR's Service Department.

Table 3
Troubleshooting the DCPF1

1	Blown Fuse	Disconnect Power and check fuse. If faulty, replace. If not, consult the factory.
2	Shorted SCR	Disconnect Power and check the SCR. Measure the resistance across the SCR and the resistance should be infinite in both directions. If a short is indicated, replace the defective SCR or return the unit to the factory for repair.
3	Defective Firing Circuit	Disconnect Power and unplug the Firing Circuit. Order a replacement Firing Circuit or return the unit to the factory.

WARNING

Always disconnect the Power source prior to attempting any servicing.

Section 6 - SERVICE AND SPARE PARTS

6-1 CUSTOMER SERVICE

If you have operational problems which cannot be resolved using this manual, please contact the Service Department at AMETEK HDR. Our normal work hours are 8 a.m. to 5:00 p.m., U.S.A. EASTERN TIME ZONE, Monday through Friday.

TELEPHONE: 1-888-797-2685 OR 614-308-5500.

Our answering machine at 614-308-5500 will answer after hours and we will return your call the next working day.

FAX: 614-308-5506. 24 hours per day automatic answering.

6-2 SPARE PARTS

Inside Sales should be contacted for any spare parts orders whether routine or emergency during normal working hours. All after hours requirements should be called in on our 614-308-5500 answering machine. Please have as much information available as possible pertaining to the model number, serial number, order number and parts required. A purchase order number should be available.

6-3 WARRANTY

AMETEK HDR warrants that the equipment delivered will be free from defects in workmanship and material for a period of five years from the date of shipment. AMETEK HDR will repair or replace, at AMETEK HDR's option, any part found defective during proper and normal use, provided that written notice of the nature of the defect is received by AMETEK HDR within the five year warranty period and that the customer returns the part to AMETEK HDR freight paid both ways. This warranty is not transferable by the initial end user.

AMETEK HDR MAKES NO OTHER WARRANTIES, EXPRESSED OR IMPLIED (INCLUDING, WITHOUT LIMITATION, MERCHANTABILITY, FITNESS FOR PURPOSE, OR AGAINST INFRINGEMENT OF ANY PATENT) EXCEPT AS EXPRESSLY PROVIDED HEREIN.

THE REMEDY OF REPAIR OR REPLACEMENT IS CUSTOMER'S SOLE AND EXCLUSIVE REMEDY AND WILL SATISFY ALL OF AMETEK HDR'S LIABILITIES, WHETHER BASED ON CONTRACT, NEGLIGENCE, TORT, PRODUCT LIABILITY, STRICT LIABILITY, OR OTHERWISE IN NO EVENT WILL HDR BE LIABLE FOR INCIDENT OR CONSEQUENTIAL DAMAGES, NOR IN ANY EVENT SHALL HDR'S LIABILITY EXCEED THE UNIT PRICE OF ANY DEFECTIVE PRODUCT OR PART.

EC DECLARATION OF CONFORMITY

WE: AMETEK HDR POWER SYSTEMS
3563 Interchange Road
Columbus, Ohio 43204 - USA

Declare under our sole responsibility that the products listed below and bearing the CE label:

Type: SCR power controllers with the following model designations and current ratings:

DCPF1 15 and 25A.
All applicable options

To which this declaration relates is in conformity with the technical requirements of the following documents:

Title: Low-voltage switchgear and controlgear	No. IEC 947-5-1 Year: 1990-03
Low Voltage Directive	No. IEC 73/23/EEC Year: 1973-02
Degrees of protection provided by enclosures (IP Code):	No. IEC 529-2nd Edition Year: 1989-11
Electromagnetic Compatibility (EMC)	No. IEC 89/336/EEC Year: 1989-05

Warning

All phase-fired (PF) controllers will require line filters and possibly shielded cables to meet the EMC requirements.

(Environmental protection classification IP00 - for mounting inside an enclosure)

Note: Characteristics are according to mfg specifications.

Name: George A. Sites

Title: Vice President

Date: July 1, 2001

Signature:

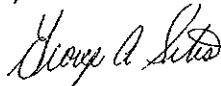

Declaration written in accordance with I.S.O. - IEC/22 Guide