

**INSTALLATION, OPERATION and
MAINTENANCE MANUAL**

**MODEL PF1, PF3 rated 60 and 90 THRU 1200
SINGLE and THREE PHASE
SCR POWER CONTROLS**

UL/cUL FILE NUMBER – E151547
CE – See last page of manual for CE Declaration of Conformity

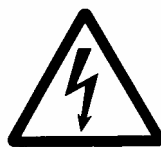

**AMETEK HDR POWER SYSTEMS
3563 INTERCHANGE ROAD
COLUMBUS, OHIO 43204**

**TEL: 614-308-5500
TOLL FREE: 1-888-PWR-CNTL (797-2685)
FAX: 614-308-5506**



SCR Power Controls/Systems & Power Supplies

Dear Client:

On behalf of all of AMETEK HDR's employees, I want to take this opportunity to "thank you" for purchasing an AMETEK HDR Power Systems' SCR Power Control.

We believe AMETEK HDR represents the best overall solution to your SCR Power Control needs in the industry today. We do this by providing a quality manufactured, reliable unit with fast, on-time delivery and a competitive price.

All of our employees are dedicated to your success. If you have any questions, comments or concerns, please call me toll free at 1-888-PWR-CNTL (797-2685).

Sincerely,

AMETEK HDR POWER SYSTEMS

A handwritten signature in cursive script that reads "George A. Sites".

George A. Sites
Vice President

GAS/be

REVISION PAGE

Page **Change**

Revision

Date

NOTE: SPECIFICATIONS SUBJECT TO CHANGE WITHOUT PRIOR NOTICE.

COPYRIGHT 2003

AMETEK HDR POWER SYSTEMS

TABLE OF CONTENTS

<u>Para.</u>	<u>Title</u>	<u>Page</u>
Section 1 - DESCRIPTION		
1-1	Models Covered	1
1-2	General Description	1
1-3	Applications	1
1-4	Specifications	1
1-5	Options	1
1-6	Operation	3
1-7	Diagnostic Indicators	3
Section 2 - INSTALLATION		
2-1	Mounting	4
2-2	Line/Load Power Wiring	4
2-3	Fan and Thermostat Wiring	5
2-4	Input Line Voltage and Frequency Changes	6
2-5	Safety Issues	6
Section 3 - COMMAND SIGNAL CALIBRATION AND WIRING		
3-1	Zero and Span Adjustments	18
3-2	Command Indicator	18
3-3	Isolated and Non-Isolated Inputs	18
3-4	Remote Manual Control	19
3-5	Process Command Signal	19
3-6	Auto/Manual Control	20
3-7	ON/OFF Control	20
3-8	Shutdown (Disable)	21
Section 4 - OPTIONS CALIBRATION		
4-1	Current Limit (CL)	23
4-2	Current Regulation (CR)	23
4-3	Overcurrent Trip (OC)	24
4-4	Power Regulation (PR)	24
4-5	Unbalance Load/SCR Failure Alarm (UB/SF)	24
4-6	Voltage, Current, Power Resistance Regulator (VIPR)	25
4-7	Current Transformer Connections	25

Section 5 - MAINTENANCE

5-1	Environmental Concerns	26
5-2	Line/Load Power Connections	26
5-3	Static Precautions When Servicing	26
5-4	Troubleshooting Typical Symptoms	26

Section 6 - SERVICE AND PARTS

6-1	Customer Service	28
6-2	Spare Parts	28
6-3	Warranty	28

TABLES AND ILLUSTRATIONS

TABLES

<u>Table</u>	<u>Title</u>	<u>Page</u>
1	Specifications	2
2	Lug Size/Torque Information - 60 through 225A Models	4
3	Fan Power Requirements	5
4	Troubleshooting Phase-Fired SCR Power Controls	27

ILLUSTRATIONS

<u>Figure</u>	<u>Title</u>	<u>Page</u>
1	Fan and Thermostat Terminals	6
2	Line/Load Power Wiring – PF1	8
3	Line/Load Power Wiring – PF3	9
4	Outline and Mounting – PF1 60 through 225A	10
5	Outline and Mounting – PF1 350 and 500A	11
6	Outline and Mounting – PF1 650A	12
7	Outline and Mounting – PF1 800 through 1200A	13
8	Outline and Mounting – PF3 60 through 225A	14
9	Outline and Mounting – PF3 350 and 500A	15
10	Outline and Mounting – PF3 650A	16
11	Outline and Mounting – PF3 800 through 1200A	17
12	Remote Manual Control	19
13	Auto/Manual Control	20
14	ON/OFF Control	21
15	Firing Circuit Terminals & DIP Switches	22

Section 1 - DESCRIPTION

1-1 MODELS COVERED

This manual covers the PF1 and PF3 models rated 60 through 1200 amperes and options, excluding the 70A PF1.

1-2 GENERAL DESCRIPTION

The PF1 is a solid-state, single-phase, phase-fired (PF) SCR Power Control. The PF3 is a solid-state, three-phase, phase-fired (PF) SCR Power Control. Each of these will operate on voltages up to 575 VAC and accept most all standard process command signals. Zero and Span Multi-turn potentiometers are provided to ease calibration. The PF1 and PF3 firing circuits utilize phase-lock loop technology to insure precise timing and noise immunity. The power SCR assembly consists of two SCRs connected back to back with a semiconductor fuse, RC. Snubber and MOV protection in each phase. Therefore the PF1 has two SCRs and the PF3 has 6. Terminals are provided to ease installation. Diagnostic indicators are provided to aid troubleshooting.

1-3 APPLICATIONS

Phase-Fired SCR Power Controllers provide infinitely variable firing angles for precise control of single or three-phase power to resistive or inductive loads. This precise control is essential for transformer coupled loads or loads with great resistance changes due to temperature or start-up. Phase-Fired units may also be used on straight resistive loads as well, but the lower power factor and higher harmonics may present a problem to other equipment mounted nearby. A zero fired model would be a better choice.

1-4 SPECIFICATIONS

Refer to Table 1 for specifications.

1-5 OPTIONS

Several options are available for the Phase-Fired models: Over-temperature Thermostat(s), Current Limit, Current Regulation, Overcurrent trip, Power Regulation, Unbalanced Load, SCR Failure and Voltage, Current, Power and Resistance Regulation (PF1 models only).

Overtemperature thermostats are available as Normally Open (NO) or Normally Closed (NC). Normally Open thermostats are standard on 90 through 1200A units but can be specified as Normally Closed at order entry. Either Normally Open or Normally Closed

thermostats may be specified on the 60A models as an option.

RMS Current Limit (Option CL) or RMS Current Regulation (Option CR) is available on all models. The Current Limit and Current Regulation options also include an Overcurrent Trip with a Form C (NO/NC contacts) relay output feature as standard. The adjustment range is approximately 30 to 125% of the unit's rating for the Current Limit and 30 to 200% for the Overcurrent Trip.

An Overcurrent Trip (Option OC) is available for those applications where either Current Limit or Current Regulation is not required. This would normally be used on loads that have instantaneous shorts that are self healing. The adjustment range is 30 to 200% and a Form C relay output is provided.

Power Regulation (Option PR) is available for use on loads with varying resistance or for any application in which the user would like the output power to be linear to the input command signal. Current Limit is provided for safety. The adjustment range is 30 to 125% for the Power Regulation and 30 to 125% for the Current Limit.

Voltage, Current, Power, Resistance Regulation (VIPR) - this option is available on PF1's only and include each of the other types of control plus resistance. This is used for experimenting with different types of feedback or for electric glass melting applications.

Table 1	
Specifications for the Phase-Fired Models	
CONTROL METHOD	- Phase firing of back to back SCRs in each phase.
VOLTAGE RATINGS	- 120, 240, 400, 480, 575VAC, 3 Ph., 50/60 Hz.
CURRENT RATINGS	- 60, 90, 120, 180, 225, 350, 500, 650, 800, 1000, 1200,
	Arms
COMMAND SIGNAL	- 4-20ma, 0-5VDC/0-10VDC, manual control.
ISOLATION	- 2500Vrms from line/load to command signal, 500Vrms to ground.
LINEARITY	- Output voltage is linear to command signal.
VOLTAGE REG.	- $\pm 1\%$ for $\pm 10\%$ line voltage change.
SCR PROTECTION	- Current surge, semi-conductor fuses; transient voltage, metal oxide varistor (MOV) and R-C snubber.
ADJUSTMENTS	- Zero and Span, multi-turn.
DIAG. INDICATORS	- Control power, command signal, blown fuse.
AMBIENT TEMP.	- Operating 0 - 50 °C, Storage -10 - 70 °C
WEIGHT (PF1)	- 60 thru 225A: 22 lbs. 350 & 500A: 24 lbs. 650A : 47 lbs 800 thru 1200A: 71 lbs
WEIGHT (PF3)	-60 thru 225A: 40 lbs. 350 & 500A: 60lbs. 650A: 126 lbs. 800 thru 1200A: 231 lbs.
AGENCY APPROVAL	- UL, cUL Listed & CE Compliant

The Unbalance Load Alarm monitors the three-phase currents and provides a relay output when the setpoint is exceeded. The SCR Failure alarm monitors the voltage drop across each individual SCR pair and provides a relay output if one SCR shorts.

1-6 OPERATION

Phase-Fired SCR Power Controllers control power by the switching action of two SCRs connected in a back to back configuration in each phase. The gating of these SCRs is synchronized with the line frequency (either 50 or 60 HZ) by the phase locked loop circuitry built into the firing circuit. A soft-start (appx a 12 cycle ramp) feature is standard, that allows the Power Controller to fire into the primary of a transformer or to control power to heating elements which have a large resistance change during start-up. The output may be adjusted by the on-board multi-turn potentiometers or by a voltage or current signal from a process controller. Zero and Span controls allow the user to calibrate the SCR unit's output to the process command signal. Terminals are available for connection of a remote manual potentiometer.

1-7 DIAGNOSTIC INDICATORS

Three diagnostic indicators (LEDs) are provided on the PF1 and five are on the PF3: Control Power (Red), lights when control power is applied; Command Signal (Green), varies in brilliance with command signal; Blown Fuse (Yellow), lights when semiconductor fuse blows – one on the PF1 and three on the PF3.

Section 2 - INSTALLATION

2-1 MOUNTING

Prior to mounting, verify the voltage and current rating. The information is provided on the unit's nameplate. Determine the mounting dimensions from the outline drawing from Figures 4, 5, 6 and 7 for the PF1 and Figures 8, 9, 10 and 11 for the PF3. Mount the unit so that air-flow is upward through the power controller. Ensure that air-flow is unrestricted. Allow plenty of room.

2-2 LINE/LOAD POWER WIRING

Connect the line/load using appropriately sized and insulated wire/cable per NEC based on the voltage and current rating of the unit. Refer to Figures 2 and 3. Cable lugs are provided on units rated 60 through 225 amps. Refer to Table 2 for lug sizes and torque information.

WARNING

Hazardous voltages exist at the power controller heat sinks and at the load at all times when the input voltage is connected. This condition exists even when the controller is set to deliver zero output.

Table 2
Lug Size/Torque Information - 60 through 225A Models

<u>Model</u>	<u>Size Wire/Cable</u>	<u>Torque</u>
60A	8 to 0 AWG	35 to 45 in. Lbs.
90A	8 to 0 AWG	35 to 45 in. Lbs.
120A	8 to 0 AWG	35 to 45 in. Lbs.
180A	6 to 250 MCM	250 in. Lbs.
225A	6 to 250 MCM	325 in. Lbs.

NOTE: 75°C rated wire (minimum) is required for all power connections.

WARNING
Branch circuit overcurrent protection is required to be provided in accordance with national and/or local code of the inspecting authority or equivalent.

2-3 FAN AND THERMOSTAT WIRING

Fans and thermostats are supplied on all units rated 90 Amps and above. The user is responsible for supplying 120VAC for the fans. Fan power should be connected to terminals 21 and 22.

CAUTION
The application of fan power should precede or coincide with the turn-on of the line voltage source that is to be controlled by SCR Power Controller.

Table 3		
Fan Power Requirements		
<u>Model</u>	<u>Power Requirements PF1</u>	<u>Power Requirements PF3</u>
60A	N/A	N/A
90A	.21A,25VA(50Hz);.19A,23VA(60 Hz)	.42A,50VA(50Hz);.38A,46VA(60Hz)
120A	.21A,25VA(50Hz);.19A,23VA(60 Hz)	.42A,50VA(50Hz);.38A,46VA(60Hz)
180A	.21A,25VA(50Hz);.19A,23VA(60 Hz)	.42A,50VA(50Hz);.38A,46VA(60Hz)
225A	.21A,25VA(50Hz);.19A,23VA(60 Hz)	.42A,50VA(50Hz);.38A,46VA(60Hz)
350A	.21A,25VA(50Hz);.19A,23VA(60 Hz)	.63A,76VA(50Hz);.57A,69VA(60Hz)
500A	.21A,25VA(50Hz);.19A,23VA(60 Hz)	.63A,76VA(50Hz);.57A,69VA(60Hz)
650A	1.4A,168VA(50 Hz);1.2A,144VA(60 Hz)	4.2A,504VA(50Hz);3.6A,432VA(60Hz)
800A	1.4A,168VA(50 Hz);1.2A,144VA(60 Hz)	4.2A,504VA(50Hz);3.6A,432VA(60Hz)
1000A	1.4A,168VA(50 Hz);1.2A,144VA(60 Hz)	4.2A,504VA(50Hz);3.6A,432VA(60Hz)
1200A	1.4A,168VA(50 Hz);1.2A,144VA(60 Hz)	4.2A,504VA(50Hz);3.6A,432VA(60Hz)

Normally Open (NO) thermostats are standard on all units rated 90 Amps and above. Normally Closed (NC) thermostats may be specified. Normally Open or Normally Closed may be specified on the 60A models as an option. Thermostat connections are on terminals 23 & 24.

**Figure 1
FAN AND THERMOSTAT TERMINALS**

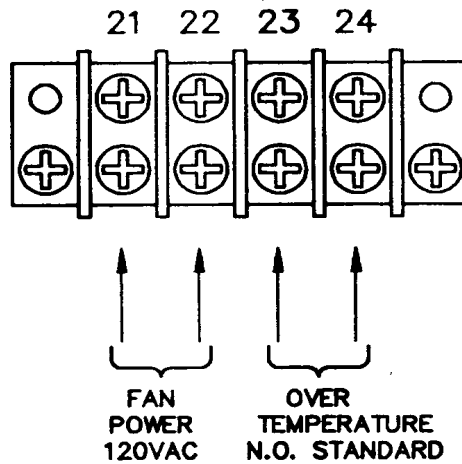

2-4 INPUT LINE VOLTAGE AND FREQUENCY CHANGES

All units are shipped wired for the line voltage specified on the purchase order. If some other voltage is required, it is a simple matter to change it. Open the door on the Power Control and locate transformer T1. Unsolder and move the White/Black wire to the appropriate voltage tap on T1. Switch SW3 must be placed in the proper position for the line frequency. On older units SW3 was preceded by Jumpers J1 and J2, which must be removed for 50 Hz. operation. In addition, the PF3 requires moving the Yellow wire to the appropriate tap on T2.

WARNING

Hazardous voltages exist at the Power Controller's heatsink and at the load at all times when the input voltage is connected. This condition exists even when the Power Controller is set to deliver zero output.

2-5 SAFETY ISSUES

The rated operational voltage of each Power Controller is shown on it's nameplate, i.e. 120V, 240V, 400V, 480V and 575V. The Power Controller is designed to operate between +10% and -15% of this rated operational voltage in an Over Voltage Category III environment.

The voltage drop across the switching semiconductor while in the conducting mode is approximately 1.5 volts and is somewhat a function of current. To calculate the Power Control's power loss,

multiply the load current times 1.5 times 1 or 3 (the number of phases).
The minimum operational current is approximately 1 Amp and the maximum off state current is approximately 15 ma.

WARNING
Power Control units are not suitable to provide isolation due to the use of semiconductors and other components that allow a small current to flow from line to load even when the unit is in the non-conducting mode.

The Power Controllers described in this instruction manual are designed to operate in a pollution degree 2 environment.



HAZARDS EXIST



DANGEROUS VOLTAGES EXIST

Figure 2
Line/Load Power Wiring – PF1

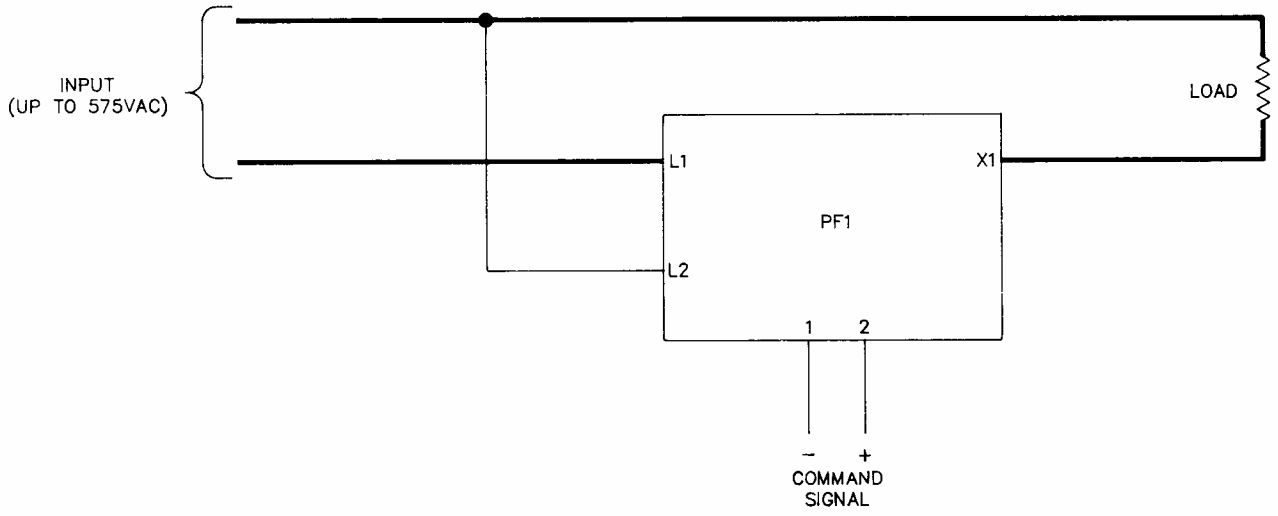

Figure 3
Line/Load Power Wiring – PF3

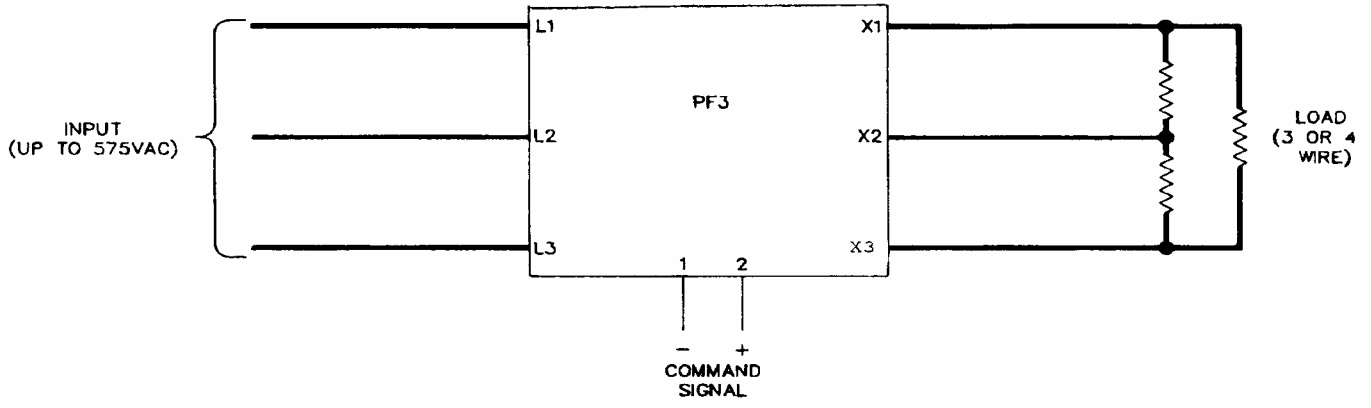

Figure 4
OUTLINE AND MOUNTING – PF1 60 THROUGH 225A

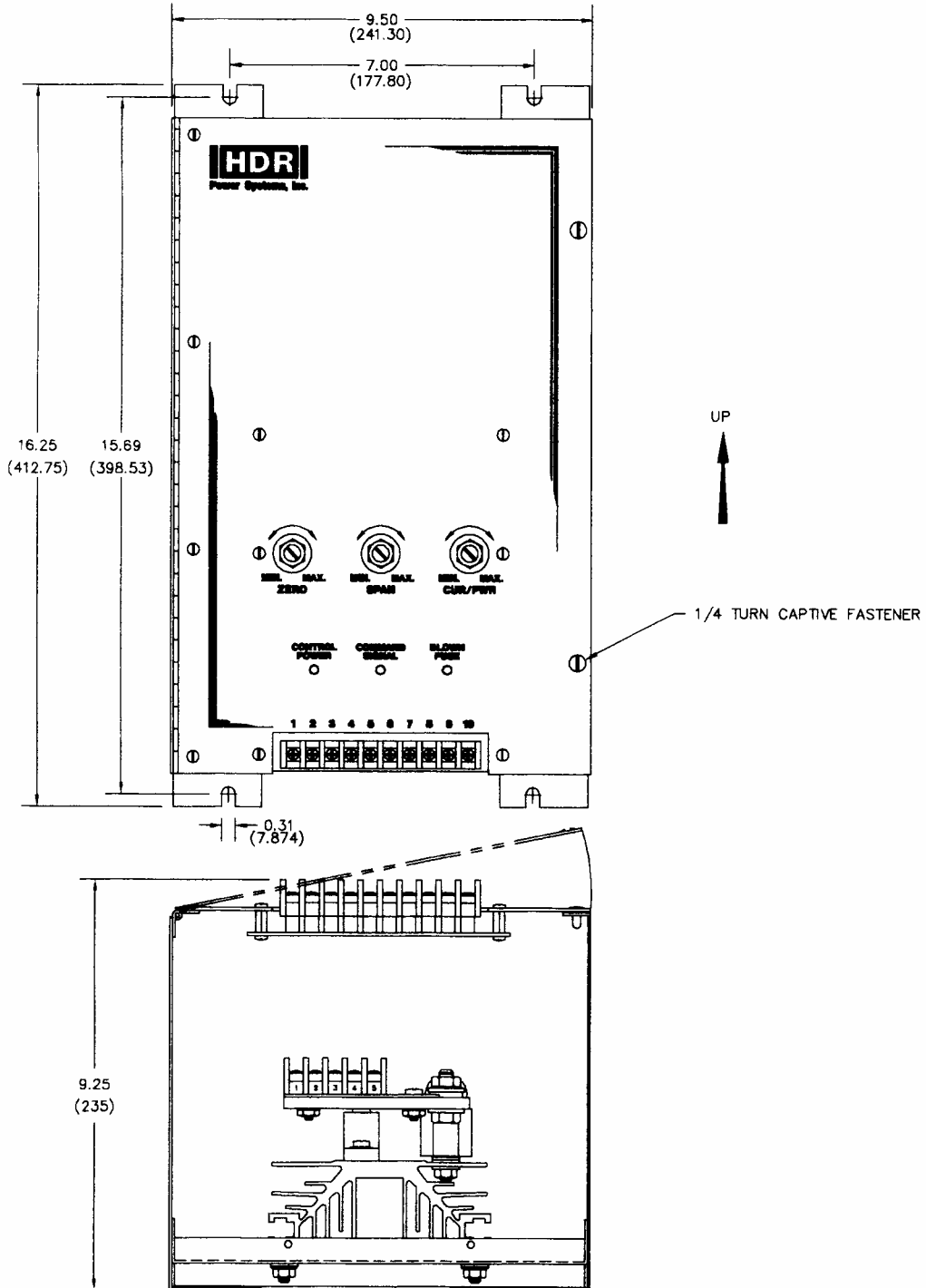

Figure 5
OUTLINE AND MOUNTING – PF1 350 AND 500A

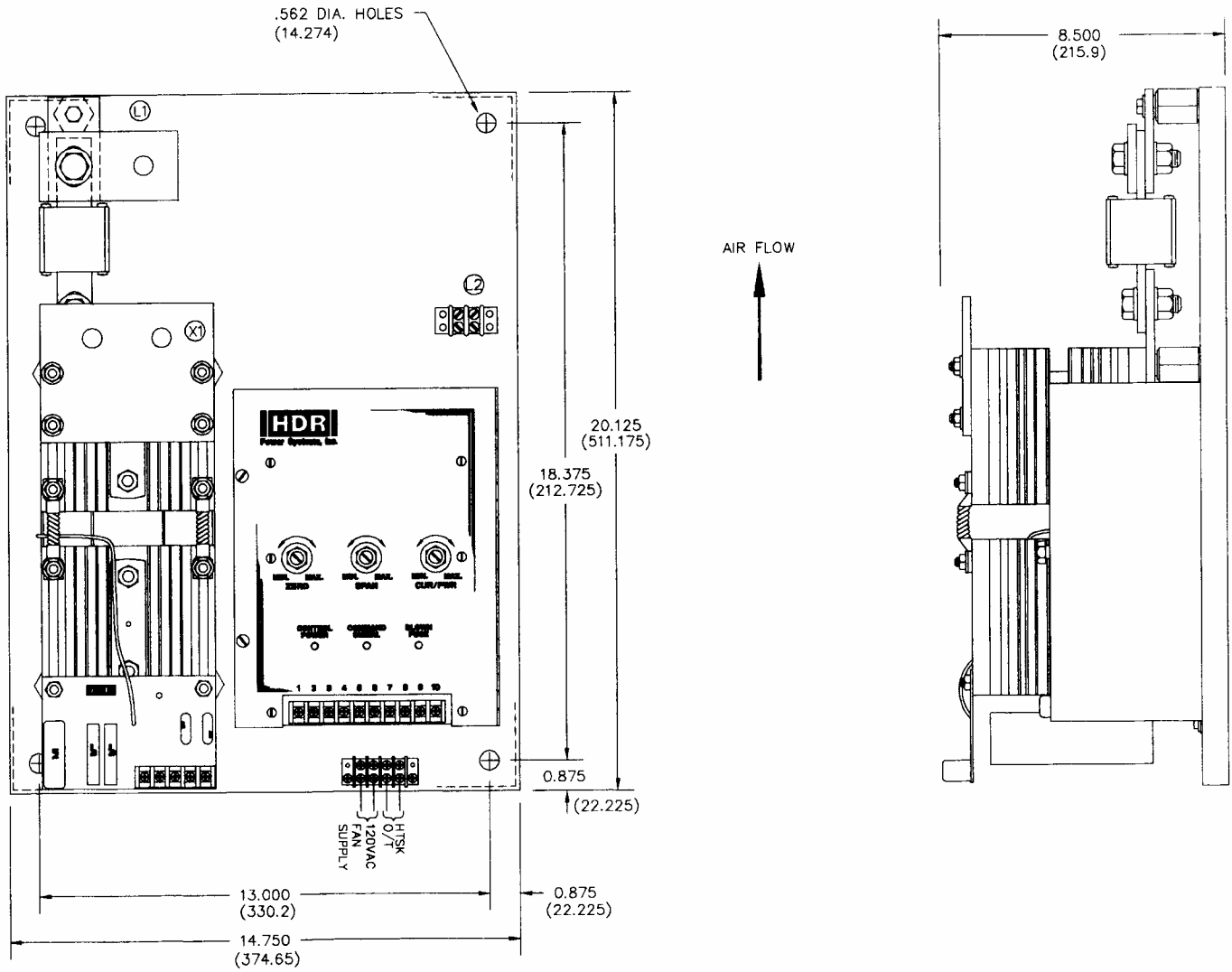

Figure 6
OUTLINE AND MOUNTING – PF1 650 A

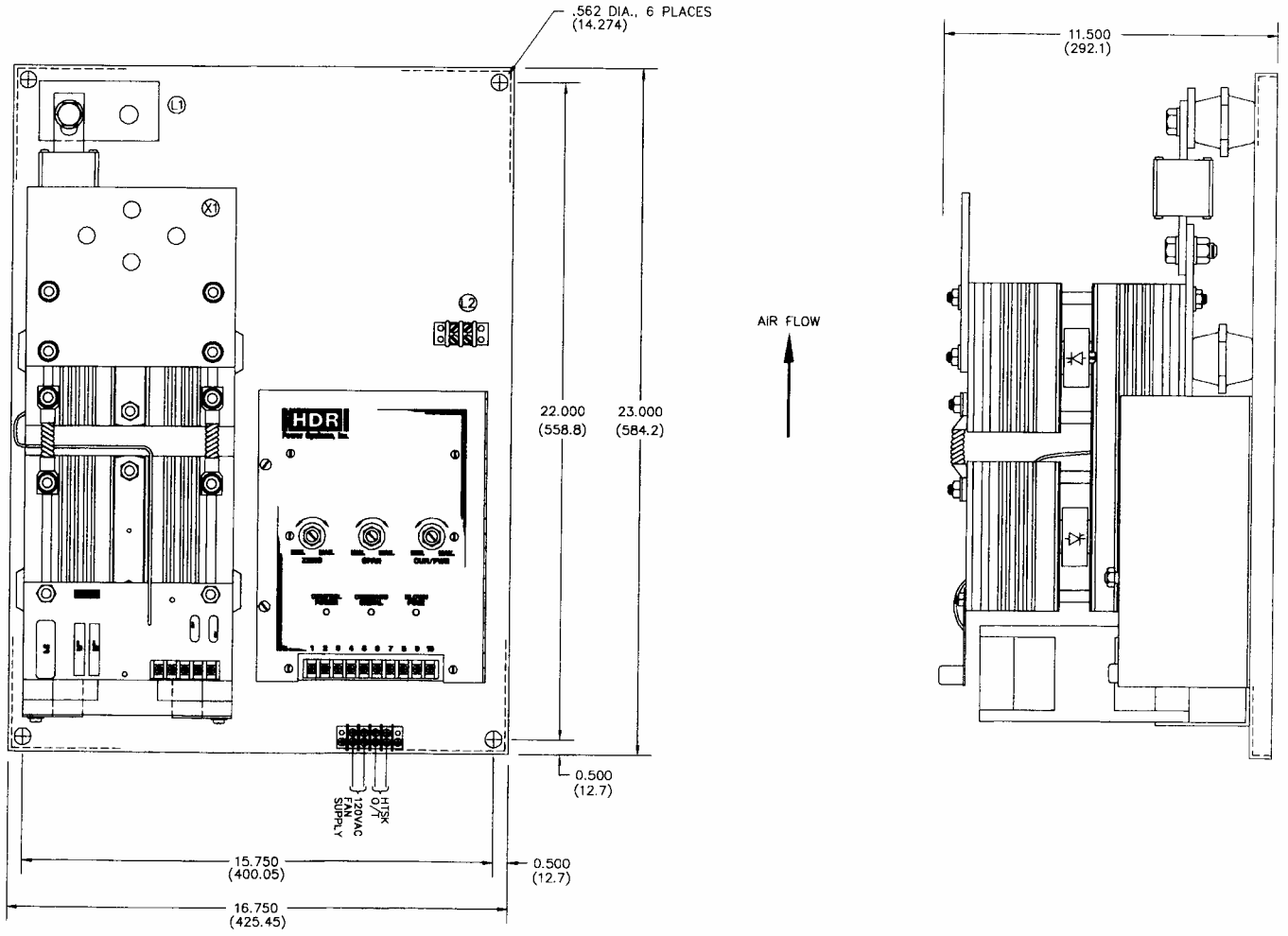

Figure 7
OUTLINE AND MOUNTING – PF1 800 through 1200 A

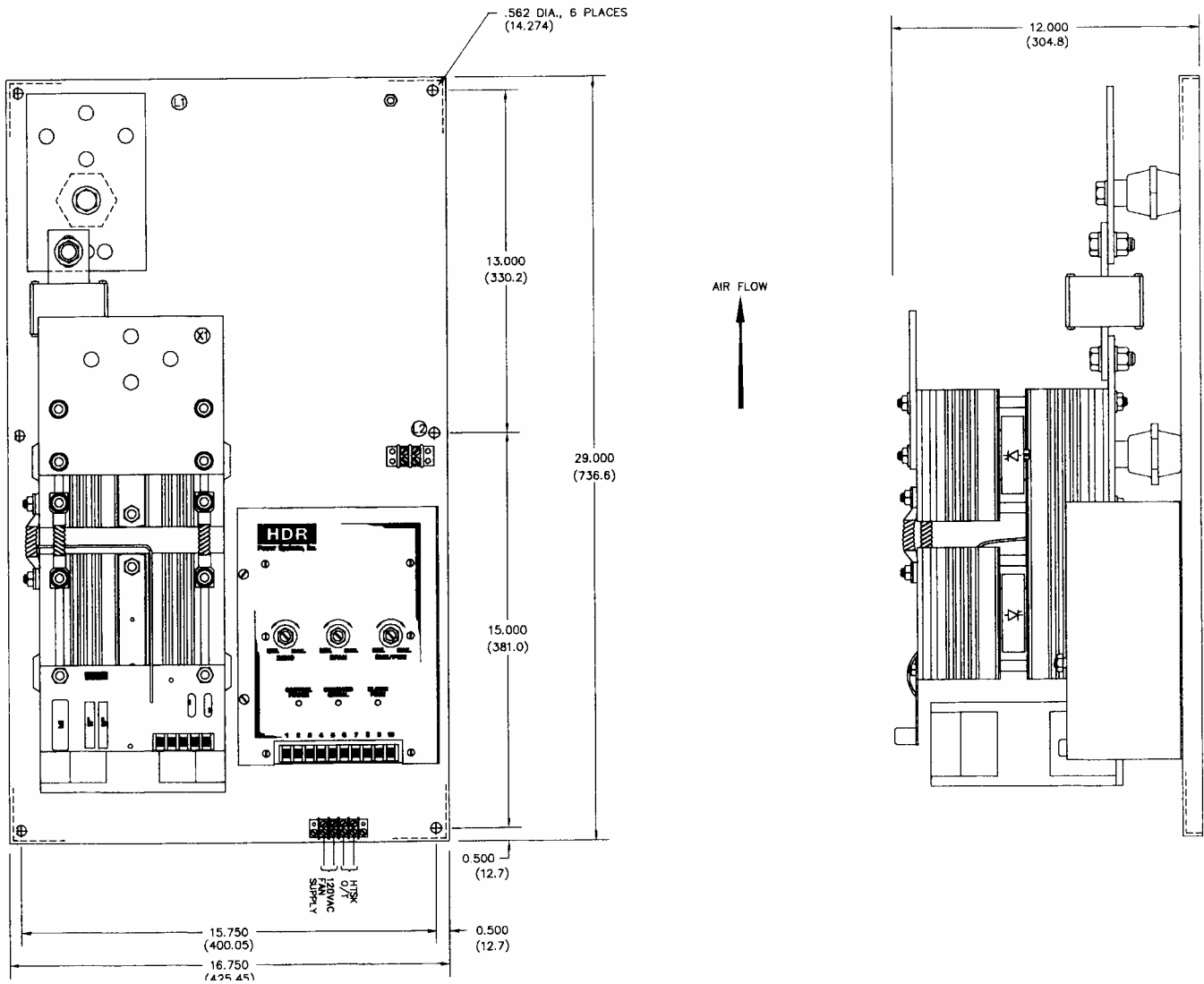

Figure 8
OUTLINE AND MOUNTING – PF3 60 through 225 A

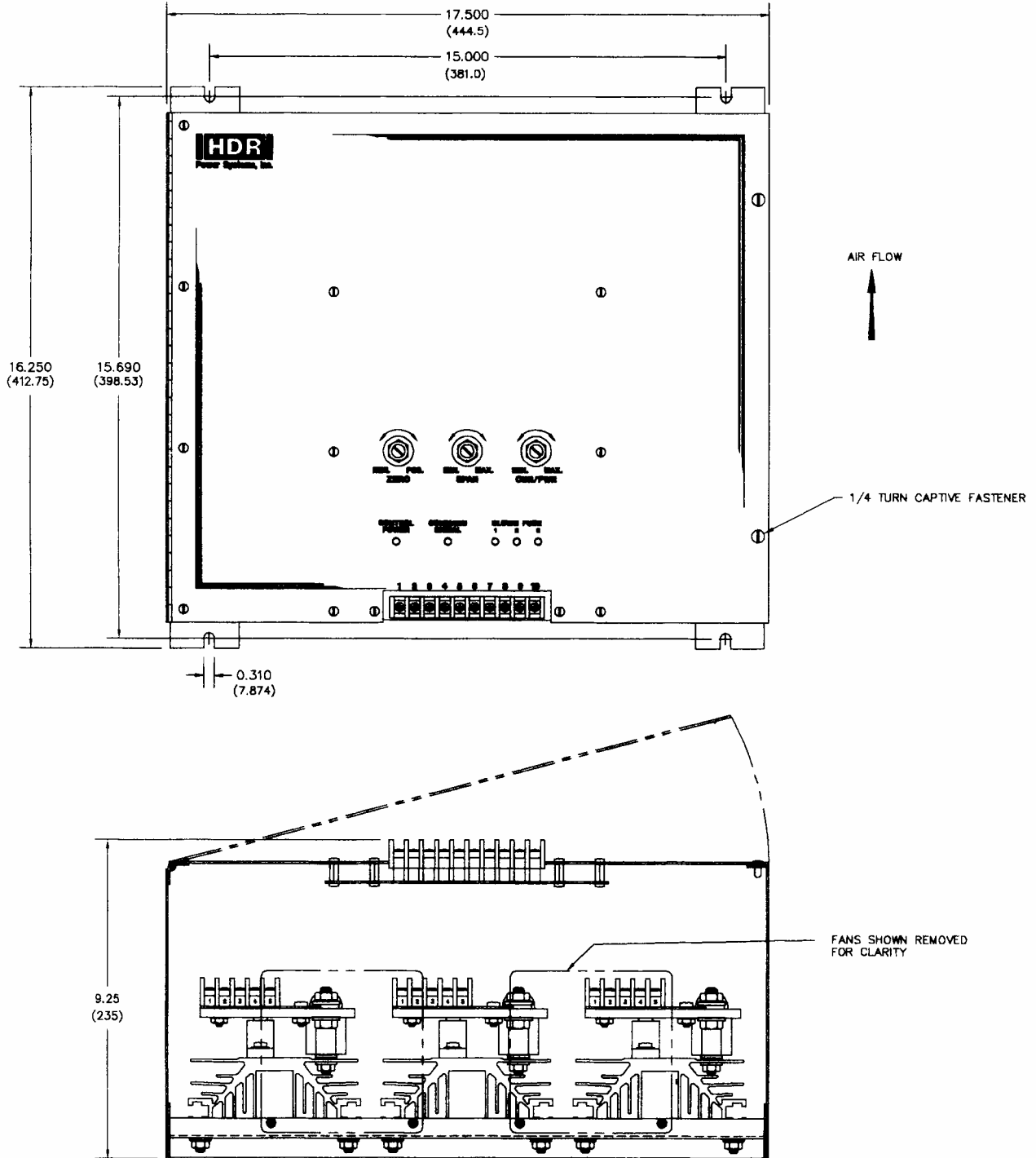

Figure 9
OUTLINE AND MOUNTING – PF 3 350 and 500 A

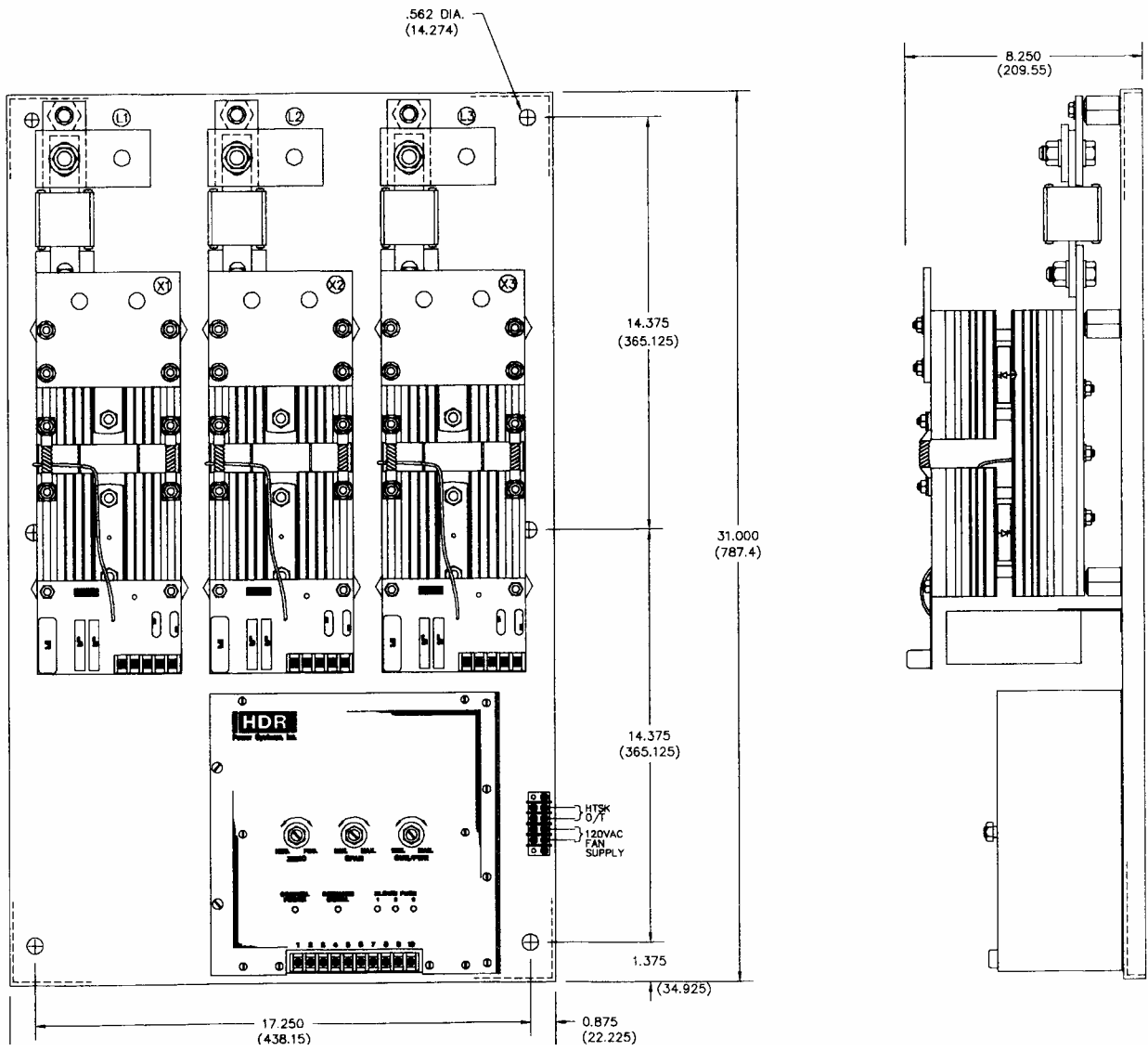

Figure 10
OUTLINE AND MOUNTING – PF3 650 A

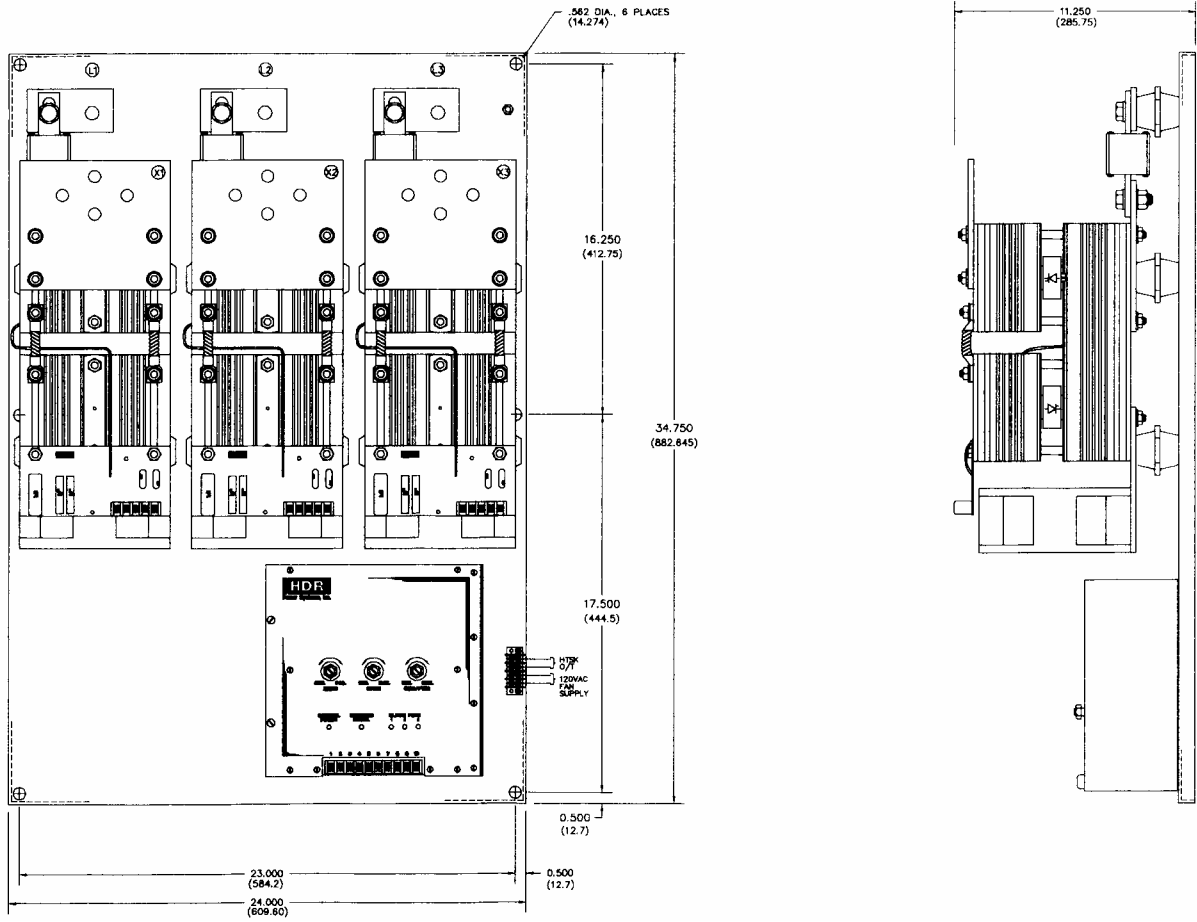
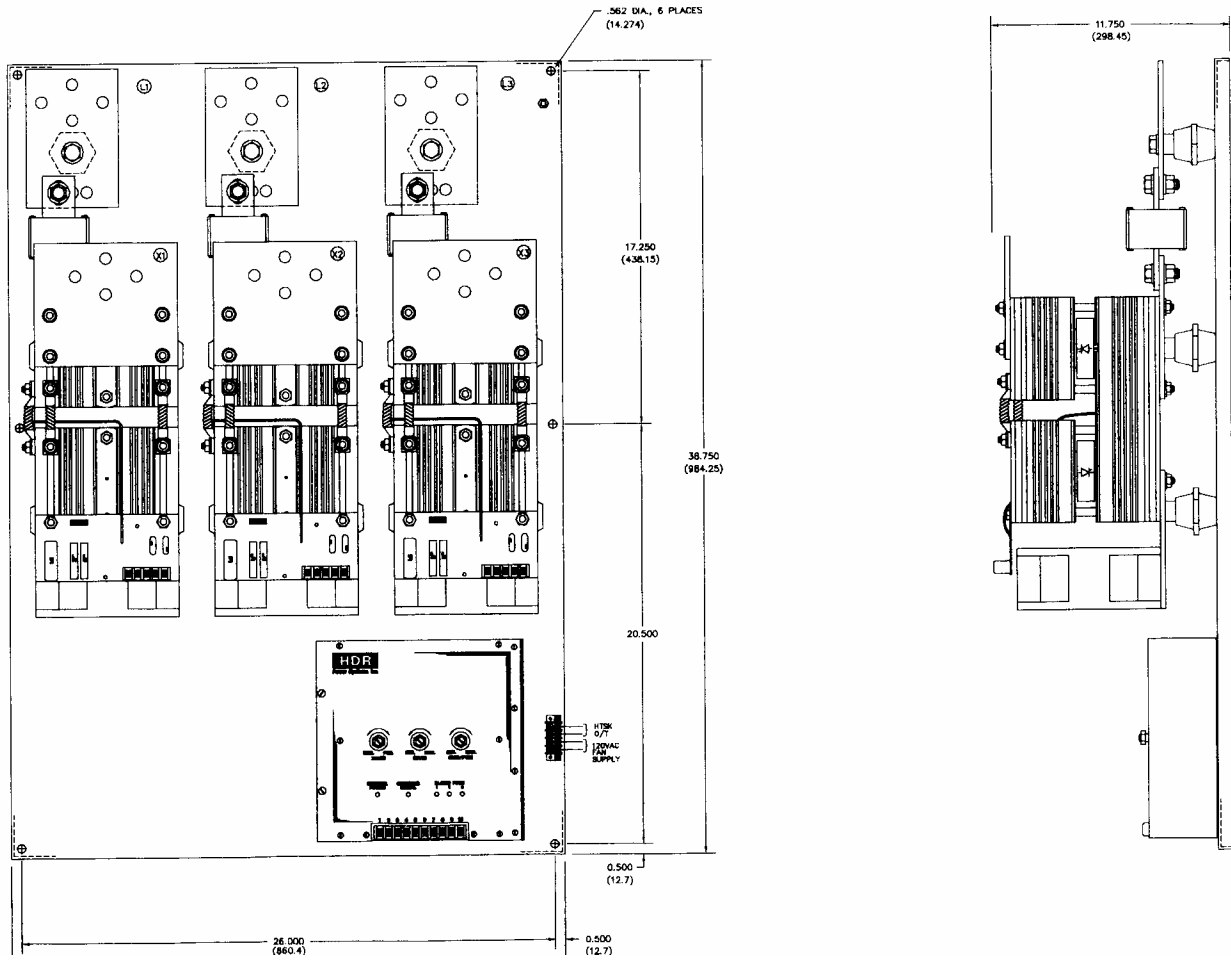

Figure 11
OUTLINE AND MOUNTING – PF3 800 through 1200 A



Section 3 - COMMAND SIGNAL CALIBRATION AND WIRING

3-1 ZERO AND SPAN ADJUSTMENTS

All PF1s have both Zero and Span potentiometers used for matching the SCR Power Control and the Command Signal. The Zero control is for the low end input (min. output) adjustments while the Span Control is used for the high end input (max. output).

The Zero control has both the negative and positive voltage available making it usable as a manual or zero control. By turning the control clockwise, the output will increase proportionally to the adjustment. Turning it counter-clockwise will decrease or zero the output.

The Span control is used to adjust the maximum desired output. It will adjust for either a remote manual control or a command signal input. Clockwise adjustment increases the output while counter-clockwise adjustment decreases the output.

3-2 COMMAND INDICATOR

The Command Indicator is a green Light Emitting Diode (LED) located on the front cover of the unit. The brilliance of this LED will change with the Command Signal. The brilliance increases with an increased Command Signal and decreases with a decreased Command Signal.

3-3 ISOLATED AND NON-ISOLATED INPUTS

HDR's Phase-Fired SCR Power Controllers have the capability of having either an isolated or non-isolated Command Signal input. It will always be shipped with an isolated input unless specified otherwise (known exception is a Manual Control input.) The standard input impedance is 500 ohms for isolated and 1500 ohms for non-isolated.

On units equipped with DIP switches, select "isolated" position for a 4-20ma command signal and "non-isolated" for a voltage input such as 0-10vdc. See Figure 15. Units without DIP switches require moving jumpers J3 and J4.

The isolated input works best with an offset Command Signal such as 4-20ma; however, it will work with both offset and zero based Command Signals. Zero based Command Signals may have a small amount of non-linearity (input to output) at the low end. This should not be a problem on closed loop systems.

3-4 REMOTE MANUAL CONTROL

Some applications only require a manual control input and not a closed loop input from a process controller. The unit is designed to accept a remote manual control input (refer to Figure 12 for connections.)

Adjustments are simple and quick, but first verify that the firing circuit is set up for non-isolated input and that R29 has been removed. Next start with the Remote Manual Control in the zero (counter-clockwise) position, apply power to the Power Control. Adjust the Zero Control so the Power Control's output just starts to come on, then adjust it counter-clockwise so the unit's output is at zero. Now adjust the Remote Manual Control to the full output (clockwise) position, and adjust the Span Control until the maximum desired output is reached. This procedure may have to be repeated due to some interaction between the Zero and Span controls.

Figure 12
REMOTE MANUAL CONTROL

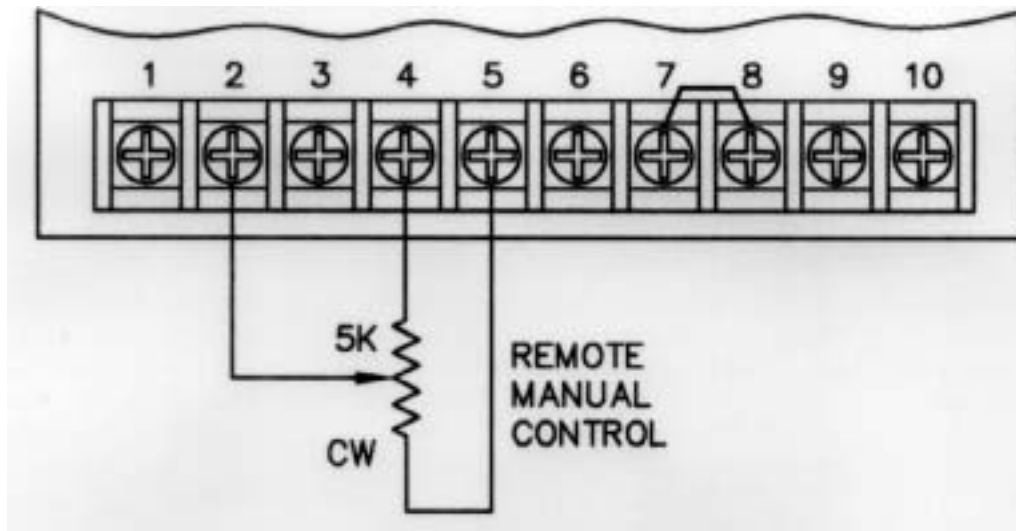

NOTE: Use RMS voltmeter to monitor output voltage.
A load must be present when making adjustments.

3-5 PROCESS COMMAND SIGNAL

Process command signals can be either offset or zero based as discussed earlier. Simply connect the command signal to terminals 1 (-) and 2 (+) on the firing circuit and adjust the Zero and Span controls. Adjustments are easy. Simply have the process controller's output set at minimum and adjust the Zero control so the unit's output is at zero. Next have the process controller's output set at maximum and adjust the Span control for the maximum desired output. As with the Remote Manual Control, some interaction between controls does exist so repeating this procedure may be necessary.

3-6 AUTO/MANUAL CONTROL

On closed loop processes it may be desirable to be able to operate the unit manually. The SCR Power Controller has this capability designed into it. Connect the Command Signal, a Remote Manual control and an Auto/Manual switch in the Auto position. By switching to the Manual position, the Remote Manual control operates and the auto signal is disconnected.

Figure 13
Auto/Manual Control

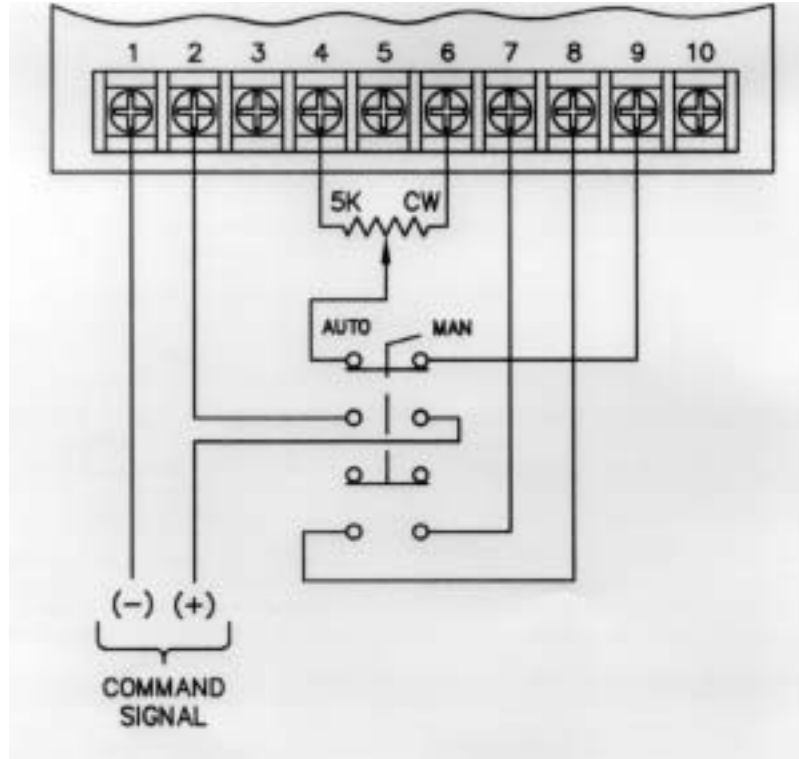

NOTE: Some non-linearity will occur with the Manual Control.

3-7 ON/OFF CONTROL

Some applications require that a simple ON/OFF type control be used. The unit can be used in these simple applications. It can be connected for turn on by a contact closure.

For on/off control, wire the contact according to figure 14. Once the wiring is complete, turn on the input power. Set the input contact to open and adjust the Zero control clockwise until the unit comes on, then adjust counter-clockwise until the unit just shuts off. Now set the input contact to the closed position and adjust the Span control clockwise until the unit's output is at the desired maximum output level. Repeating of this procedure may be necessary due to some interaction between the Zero and Span controls.

Figure 15
 FIRING CIRCUIT TERMINALS

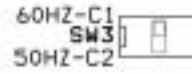
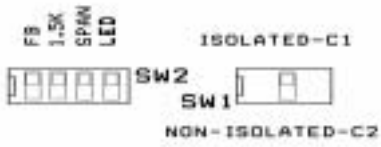
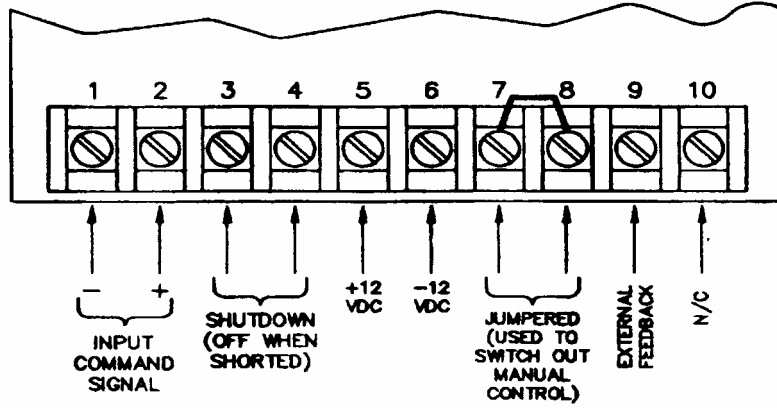

Section 4 - OPTIONS CALIBRATION

NOTE: The Zero and Span Controls should be adjusted prior to adjusting any of the options. The options have been factory set, but if the option's adjustments are questionable, re-adjust the controls to full clockwise, and then proceed with the following adjustments. Most likely no adjustment of the option will be required. Always use a true RMS reading ammeter when making adjustments.

4-1 CURRENT LIMIT (CL)

The available Current Limit is a true RMS current limiting device that includes an overcurrent trip circuit. The adjustment range for the current limit is approximately 30 to 125% of the unit's rating and 30 to 200% for the overcurrent trip. Both adjustments are multi-turn potentiometers. The current limit adjustment is on the front of the PF1, while the overcurrent trip adjustment is inside on the current limit PCB.

If adjustment is required, adjust the command signal to full on. Next adjust the Current Limit control counter-clockwise from full clockwise position. Stop adjusting when the unit's RMS output current is at the desired maximum level. Next adjust the overcurrent trip control counter-clockwise until the unit trips off, then adjust it clockwise a small amount. This may require a few tries. Refer to paragraph 4-3 for overcurrent relay output, and remote reset PB connections.

4-2 CURRENT REGULATION (CR)

The Current Regulation option is much like the Current Limit. It includes an overcurrent trip feature, but regulates the RMS current rather than limiting it. The adjustment range is 30 to 125% of the unit's rating for the current regulation and 30 to 200% for the overcurrent trip. The current regulation option adjustment is on the front of the unit, while the overcurrent trip adjustment is located on the current regulation PCB on the inside of the unit. The internally mounted Feedback Switch must be in the off position.

With the command signal at full, adjust the current regulation control until the maximum RMS output current is reached. The output RMS current will be linear to the command signal.

Re-adjust the overcurrent trip control as described in paragraph 4-1. Refer to paragraph 4-3 for overcurrent relay output and remote reset PB connections.

4-3 OVERCURRENT TRIP (OC)

This option is for those applications which do not require current limit or regulation, but is likely to suffer from instantaneous faults in the load.

The overcurrent trip adjustment is on the front of the unit. It's adjustment range is from 30 to 200% of the unit's current rating.

If adjustment is necessary, have the command signal set at maximum and adjust the overcurrent trip control as necessary until the unit shuts off. Re-adjust the control clockwise until the unit will operate properly.

Another feature of the overcurrent trip is an automatic reset. This is included with the current limit and current regulation. Open the unit and locate the auto reset switch and reset pushbutton. With this switch in the on position, the unit will continue to reset until the fault clears. If in the off position, the unit will remain shut off until the reset PB is operated. The auto reset switch will always be in the off position unless specified on the order.

All overcurrent trips includes a Form C relay output and provisions for a remote overcurrent reset PB. The relay output terminals for the PF1 are 35 and 36 for the N.C. and 36 and 37 for the N.O. The remote reset PB connects to terminals 33 and 34. On the PF3 the terminals are 39 and 40 for the N.C. and 40 and 41 for the N.O. The remote reset terminals are 37 and 38.

4-4 POWER REGULATION (PR)

This option is for applications where it is desirable to regulate the true power instead of the RMS current. This option also includes a RMS current limit as a safety feature. The Power Regulation control is on the front of the unit while the Current Limit control is inside on the Power Regulation PCB. The adjustment range is 30 to 125% for both the power regulation and current limit.

The adjustments are simple and are similar to the current regulation adjustments. With the command signal set for maximum output, adjust the Power Regulation control until the desired maximum power is obtained. The input command signal to the output true power will now be a linear relationship. Re-adjust the current limit if required.

4-5 UNBALANCE ALARM AND SCR FAILURE (UB/SF)

This option provides a Form C relay output for monitoring the balance of the 3 phase currents or for an SCR failure. Refer to the Unbalance Alarm manual for operational and set-up instructions.

4-6 VOLTAGE, CURRENT, POWER, RESISTANCE REGULATION (VIPR)

This option allows you to operate in any one of 4 modes. Simply slide the specific mode switch to “on”, insure all others are “off”. Adjustments and operating ranges are the same as mentioned for each individual option. Please call the factory if you have any questions.

4-7 CURRENT TRANSFORMER CONNECTIONS

For the current limit, current regulation, overcurrent trip and the power regulation option, the remotely mounted current transformer on the PF1 (5A secondary) should be used connected to terminals 31 and 32. On the PF3 Phase 1 CT connects to terminals 31 and 32; Phase 2 CT connects to terminals 33 and 34; and Phase 3 CT connects to terminals 35 and 36. If erratic control is noticed (power regulation only) reverse the current transformer secondary connections.

The VIPR current transformer connects to terminals 92 and 93. .

Section 5 - MAINTENANCE

5-1 ENVIRONMENTAL CONCERNS

Always verify that the SCR Power Control is mounted in a clean, dust free environment. Clean the heat sink and printed circuit board periodically so no dust and/or dirt accumulates on the unit. Dust and/or dirt on the heat sink fins can prevent proper airflow causing overheating of the semiconductors. Conductive dust and/or dirt can cause shorts or arcing, which can cause damage to the unit.

Always size your enclosure so that a 50 °C maximum internal ambient temperature is never exceeded.

5-2 LINE/LOAD POWER CONNECTIONS

Periodically turn the power off to the SCR Power Controller and check for corrosion and tightness of the power connections. If any corrosion is evident, clean the cable and connector and reconnect making sure to tighten according to our torque specifications in Table 2.

5-3 STATIC PRECAUTIONS WHEN SERVICING

When servicing the Firing Circuit or option Printed Circuit Board (PCB), damage can occur due to static electricity. Always use a wrist strap grounded through a 1 megohm resistor. Transport the PCB in a static shielding bag. Caution in handling the PCB can help prevent any further damage to the PCB.

If you are not familiar with static precautions, consult the factory for additional details.

5-4 TROUBLESHOOTING TYPICAL SYMPTOMS

Any one of the following symptoms usually indicate a problem:

1. No output regardless of the input.
2. Full output regardless of the input.
3. Output is not variable from 0 to full.

Refer to Table 3 for help in troubleshooting. If you cannot diagnose the problem, call HDR's Service Department.

Table 4
Troubleshooting Phase-Fired SCR Power Controllers

<u>Symptom</u>	<u>Cause</u>	<u>Solution</u>
1	Open Fuse	Disconnect power and check the fuse. Replace if faulty. If not, contact the factory.
2	Shorted SCR	Disconnect power and check the SCRs. Measure the resistance across each pair of SCRs and the resistance should be infinite in both directions. If a short is indicated, replace the defective SCR or return the unit to the factory.
3	Defective Firing Ckt.	Disconnect power and unplug the Firing Circuit. Order a replacement Firing Circuit or return the unit to the factory.

WARNING

**Always disconnect the source prior
to attempting any servicing.**

Section 6 - SERVICE AND SPARE PARTS

6-1 CUSTOMER SERVICE

If you have operational problems which cannot be resolved using this manual, please contact the Service Department at AMETEK HDR. Our normal work hours are 8 a.m. to 3:30 p.m., U.S.A. EASTERN TIME ZONE, Monday through Friday.

TELEPHONE: 1-888-PWR-CNTL (797-2685) OR 614-308-5500.

Our answering machine at 614-308-5500 will answer after hours and we will return your call the next working day.

FAX: 614-308-5506. 24 hours per day automatic answering.

6-2 SPARE PARTS

Inside Sales should be contacted for any spare parts orders whether routine or emergency during normal working hours. All after hours requirements should be called in on our 614-308-5500 answering machine. Please have as much information available as possible pertaining to the model number, serial number, order number and parts required. A purchase order number should be available.

6-3 WARRANTY

AMETEK HDR warrants that the equipment delivered will be free from defects in workmanship and material for a period of five years from the date of shipment. AMETEK HDR will repair or replace, at AMETEK HDR's option, any part found defective during proper and normal use, provided that written notice of the nature of the defect is received by AMETEK HDR within the five year warranty period and that the customer returns the part to AMETEK HDR freight paid both ways. This warranty is not transferable by the initial end user.

AMETEK HDR MAKES NO OTHER WARRANTIES, EXPRESSED OR IMPLIED (INCLUDING, WITHOUT LIMITATION, MERCHANTABILITY, FITNESS FOR PURPOSE, OR AGAINST INFRINGEMENT OF ANY PATENT) EXCEPT AS EXPRESSLY PROVIDED HEREIN.

THE REMEDY OF REPAIR OR REPLACEMENT IS CUSTOMER'S SOLE AND EXCLUSIVE REMEDY AND WILL SATISFY ALL OF AMETEK HDR'S LIABILITIES, WHETHER BASED ON CONTRACT, NEGLIGENCE, TORT, PRODUCT LIABILITY, STRICT LIABILITY, OR OTHERWISE. IN NO EVENT WILL AMETEK HDR BE LIABLE FOR INCIDENT OR CONSEQUENTIAL DAMAGES, NOR IN ANY EVENT SHALL HDR'S LIABILITY EXCEED THE UNIT PRICE OF ANY DEFECTIVE PRODUCT OR PART.

EC DECLARATION OF CONFORMITY

WE: AMETEK HDR POWER SYSTEMS
3563 Interchange Road
Columbus, Ohio 43204 - USA

Declare under our sole responsibility that the products listed below and bearing the CE label:

Type: SCR power controllers with the following model designations and current ratings:

ZF1, ZF2, ZF3, PF1, PF3 - 15, 25, 40,
60, 70, 90, 120, 180, 225, 350, 500,
650, 800, 1000 and 1200A.
SHZF1, SHPF1 - 15, 30, 40, 60, 70, 90
and 120A
SHZF2, SHZF3, SHPF3 - 15, 25, 30, 60, 90, 120, 180 and
225A
SCZF1, SCPF1 - 15, 25, 40 and 65A
All applicable options

To which this declaration relates is in conformity with the technical requirements of the following documents:

Title: Low-voltage switchgear and control gear	No. IEC 947-5-1 Year: 1990-03
Low Voltage Directive	No. IEC 73/23/EEC Year: 1973-02
Degrees of protection provided by enclosures (IP Code):	No. IEC 529-2nd Edition Year: 1989-11
Electromagnetic Compatibility	No. IEC89/336/EEC Year: 1989-05

Warning

All phase-fired (PF) controllers will require line filters and possibly shielded cables to meet the EMC requirements.

(Environmental protection classification IP00 - for mounting inside an enclosure)

Note: Characteristics are according to mfg specifications.

Name: George A. Sites

Title: Vice President

Date: November 9, 2000

Signature:

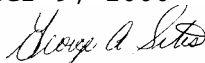

Declaration written in accordance with I.S.O. - IEC/22 Guide